

LED LINEAR STRIP

Installation Manual

<p>Step1</p>  <p>Turn off the switch</p>	<p>Step2</p> 
<p>Step3</p> 	<p>Step4</p>  <p>AC-N Connect to AC-N</p> <p>AC-L Connect to AC-L</p> <p>AC-L Connect to Wall Switch</p> <p>Connect to GND</p> <p>WHITE</p> <p>YELLOW</p> <p>BLACK</p> <p>GND</p>
<p>Step5</p> 	<p>Step6</p> <p>Turn on the switch</p> 

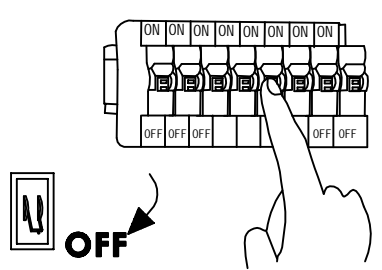
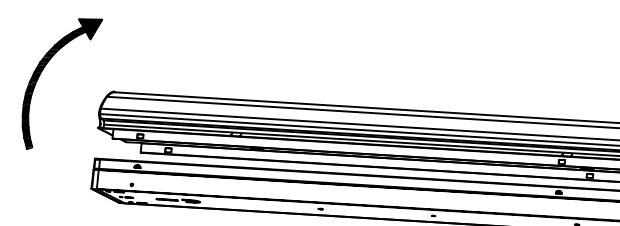
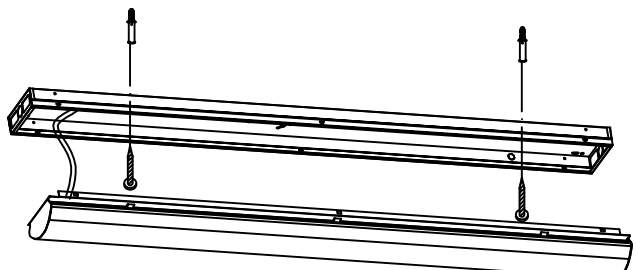
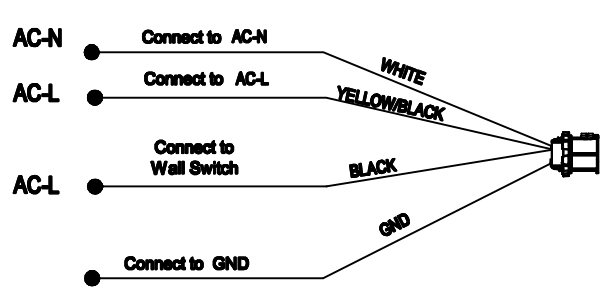
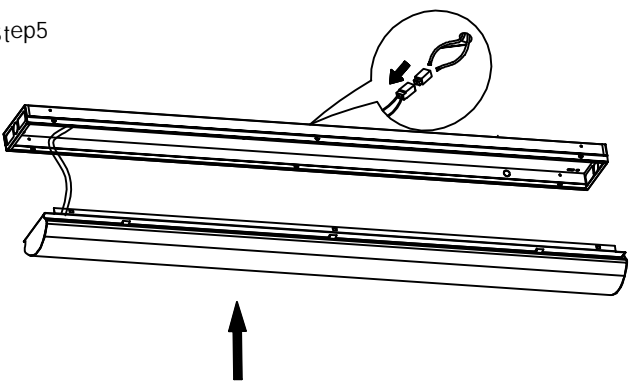
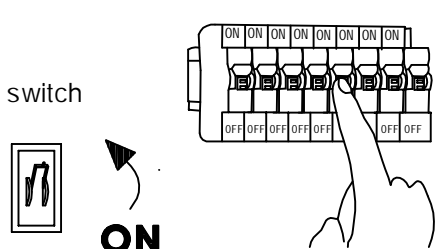
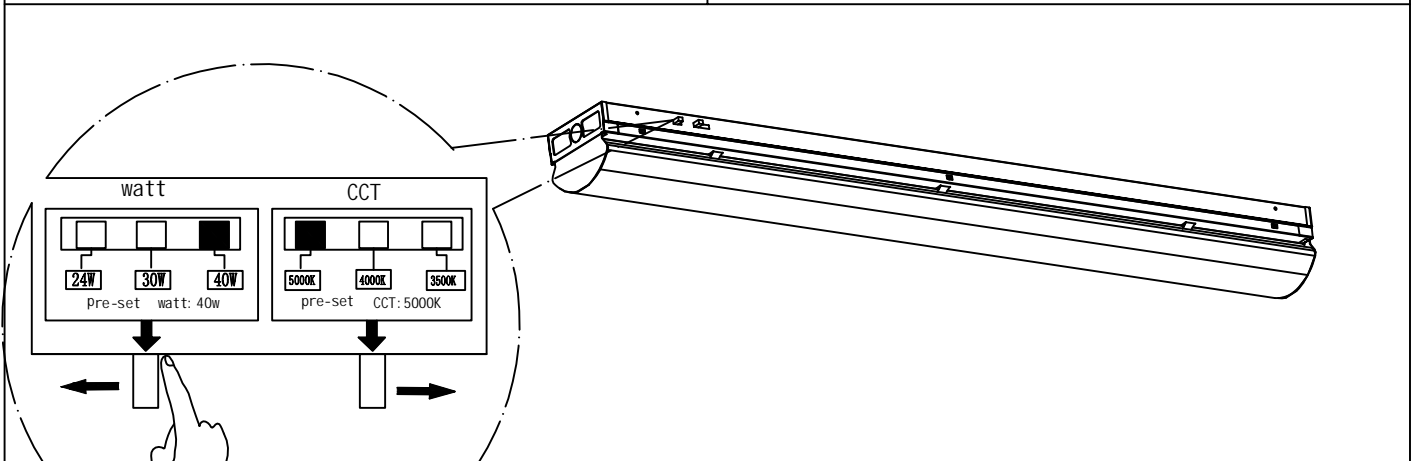

watt

CCT

24W 30W 40W

Pre-set watt: 40w

5000K 4000K 3500K

Pre-set CCT: 5000K

Caution: Please note that DO NOT use this Product in the following Places/application

1. The Place has a large quantity of lampblack and smoke, such as: kitchen and Food Processing factory etc.
2. The Place has a large quantity of chemical corrosive substance, such as: chemical Plant and stock Yard etc.
3. The Place has poor temperature conditions, large-scale temperature variation, which would easily lead to broken and damage the Product, the applicable operating temperature is between -15 and 45 degrees.